

Warmup



Warmup Foil Heater

Installation manual

SAFETY Net[™]
Installation-Guarantee



Warmup

The world's best-selling floor heating brand™

Over 2.7 million installations
in more than 72 countries

Experience MyHeating™



SmartGeo™

Unique SmartGeo™ automatically turns down the heating when you're out.



Easy to use

Simple and secure setup using WiFi, with 24/7 technical support.



AutoSwitch™

Always on the best tariff, automatically. Reduce energy bills by over £400

Download now for iOS and Android



611 08 WiFi Thermostat



www.warmup.co.uk

Table of Contents

Safety information	4
Installation summary	6
Components available from Warmup	9
Step 1 - Electrical supply	10
Typical floor build-ups	14
Engineered floating floors	14
LVT / Vinyl / Laminate	15
Step 2 - Subfloor considerations	16
Step 3 - Subfloor preparation	17
Step 4 - Layout planning	18
Step 5 - Install the Foil heater	22
Step 6 - Select floor covering	24
Step 7 - Lay the Floor Covering	25
Step 8 - Connect the thermostat	26
Connect the thermostat (Load exceeding 16 Amps)	27
Troubleshooting	28
Performance troubleshooting	30
Testing information	32
Technical specifications	34
System performance	36
Warranty	38
Control card	39
EcoDesign compliance information card	40
SafetyNet Installation Guarantee	41
Notes	42















Your Warmup heating system has been designed so that installation is quick and straight forward, but as with all electrical systems, certain procedures must be strictly followed. Please ensure that you have the correct heating mat(s) for the area you wish to heat. Warmup plc, the manufacturer of the Warmup Foil heater system, accepts no liability, expressed or implied, for any loss or consequential damage suffered as a result of installations which in any way contravene the instructions that follow.

It is important that before, during and after installation that all requirements are met and understood. If the instructions are followed, you should have no problems. If you require help at any stage, please contact our helpline.













You may also find a copy of this manual, wiring instructions and other helpful information on our website:

www.warmup.co.uk

Safety information

-  Perform a site inspection. You will need to confirm that all measurements and other requirements on site match your working drawings.
-  Inspect the site for possible hazards that could damage the heating mat, such as nails, staples, materials or tools. Ensure that during the course of the installation no damage is caused to the heating mat by falling or sharp objects.
-  Ensure all electrical connections conform to the current BS 7671 National Wiring Regulations. Final connections to the main electricity supply MUST be completed by a Part P qualified electrician.
-  Ensure the system is protected by a dedicated 30 mA RCD/RCBO or an existing RCD/RCBO). Time delay RCD's must not be used.
-  Ensure the Control card, EcoDesign compliance card at the back of the manual, layout plan, and all electrical test records are completed and affixed to the consumer unit, following the current BS 7671 standards.
-  The subfloor must be pre-insulated unless it is an intermediate floor. Ensure the subfloor is prepared to an SR1 Surface Regularity. The subfloor must be smooth, dry, frost-free, solid, suitably weight-bearing and dimensionally stable.
-  Ensure suspended timber subfloors are prepared in accordance with national standards and that manufacturer instructions are properly followed to avoid subfloor movement to prevent any damage to the system.
-  Install the floor sensor centrally between two parallel runs of heating cable and away from other heat sources such as hot water pipes, lighting fixtures, chimneys etc. Do not cross the sensor over the heating element.
-  Before installing the floor finish, its suitability for use with underfloor heating and its maximum operating temperature should be checked against required operating conditions. Ensure the heat output of the floor meets your requirements.
-  Install floor coverings which are at least 5 mm thick. For floor coverings other than floating floors, lay Warmup WDO / HiDeck18 over the heater first. Check with flooring manufacturer for suitability with floor heating.
-  Ensure glues/adhesives used over Warmup Dual Overlay/Hideck18 are compatible with underfloor heating and suitable for application with electric underfloor heating systems.
-  Consideration should be given to the thermal resistance and temperature limits of the chosen floor covering and its impact on the system heat output.
-  Ensure all furniture installed over underfloor heating has feet, creating a minimum 50 mm ventilated space beneath it to allow heat flow into the room.
-  This appliance can be used by children aged from 8 years and above and persons with reduced physical, sensory or mental capabilities or lack of experience and knowledge if they have been given supervision or instruction concerning use of the appliance in a safe way and understand the hazards involved. Children shall not play with the appliance. Cleaning and user maintenance shall not be made by children without supervision.

Safety information

-  The coldtail can be cut / extended where required. This heating mat has a type Y coldtail attachment, therefore if the coldtail is damaged, it must be replaced by the manufacturer, its service agent or similarly qualified persons in order to avoid a hazard.
-  Insulation **MUST** be used below the Warmup Foil Heater and **MUST** be minimum 6 mm thick and $\leq 500\text{kPa}$ compressive strength.
-  **DO NOT** cut, shorten or extend the heating cable. The heating mat must not overlap or be installed over coldtails.
-  **DO NOT** leave surplus heating mat rolled up under units or fixtures, use the correct size system for your installation.
-  **DO NOT** attempt a DIY repair if you damage the heating cable, contact Warmup for assistance.
-  **DO NOT** tape over the floor sensor tip. Doing so will cause air pockets and damage the sensor.
-  **DO NOT** install items above the heating system which have a combined resistance of more than $0.175 \text{ m}^2\text{K/W}$. Such items include bean bags, heavy rugs, flat furniture, animal beds or mattresses.
-  **DO NOT** bend the heating cable under 25 mm radius.
-  **DO NOT** install the heating mat in ambient temperatures less than 0°C .
-  **DO NOT** install any levelling compounds/tile adhesives over the heating mat or have the mat in direct contact with a cement or concrete subfloor or slab. There must always be a suitable underlay underneath the heater.
-  **DO NOT** install the system on irregular surfaces such as on stairs or up walls.
-  **DO NOT** use staples to secure the heating mat to the subfloor.
-  **DO NOT** install the heating mat in locations where they will increase the ambient temperature of any existing electrical installation above its rated value.

Symbols used in manual

WARNING! Radiant direct floor heating system.

Risk of shock or fire

Failure to comply with local wiring regulations or the contents of this manual may result in electric shock or fire!



Important information



Installation summary

Please also read the full instructions that follow this section.



- Make electrical provision for the system (30 mA RCD, overcurrent protection, 35 mm deep electrical back boxes, trunking).



- The subfloor must be pre-insulated unless it is an intermediate floor. Ensure the subfloor is prepared to an SR1 surface regularity. The subfloor must be smooth, dry, frost-free, solid, suitably weight-bearing and dimensionally stable.



- Install Warmup Insulated Underlay referring to its instructions. Insulation **MUST** be used below the Warmup Foil Heater and **MUST** be minimum 6 mm thick and $\leq 500\text{kPa}$ compressive strength.



- Cut a section in the underlay for the coldtail joint and coldtail so that it sits at the same height as the heater.
- Secure the coldtail using tabs of electrical tape as necessary.

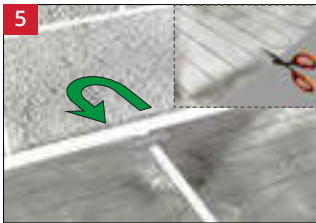

- Begin laying the heating mat, cutting the mat and turning/rotating the mat to fit the floor area.
- Any exposed sections of heating cable **MUST** be bridged with the aluminium foil strips provided. This is required to maintain the earth continuity of the mat.

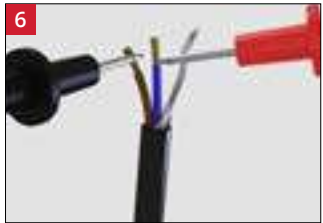

- Test the resistance of the heating mat ensuring it is within the range set out in the Reference Resistance Band table.

Installation summary



- At the end of the mat, you will find a termination joint. As with the coldtail joint at the beginning of the heating mat, this joint will have to be cut into the underlay so that it sits at the same height as the heater.



- Install the floor sensor centrally, 300mm in between two parallel runs of heating cable and away from other heat sources such as hot water pipes, lighting fixtures, chimneys etc. Do not cross the sensor over the heating elements.



- Test the resistance of the heating mat after installation and check against the previous value to ensure no damage has occurred.



- Lay your chosen floor covering over the heating system.
- For LVT / Vinyl / Laminate floor coverings Warmup Dual Overlay MUST be installed first.



- Test the resistance of the heating mat after the floor has been laid to check against previous values to ensure no damage has occurred.



- Install your Warmup thermostat referring to their installation instructions. The system must be connected to and controlled with a thermostat and sensor.

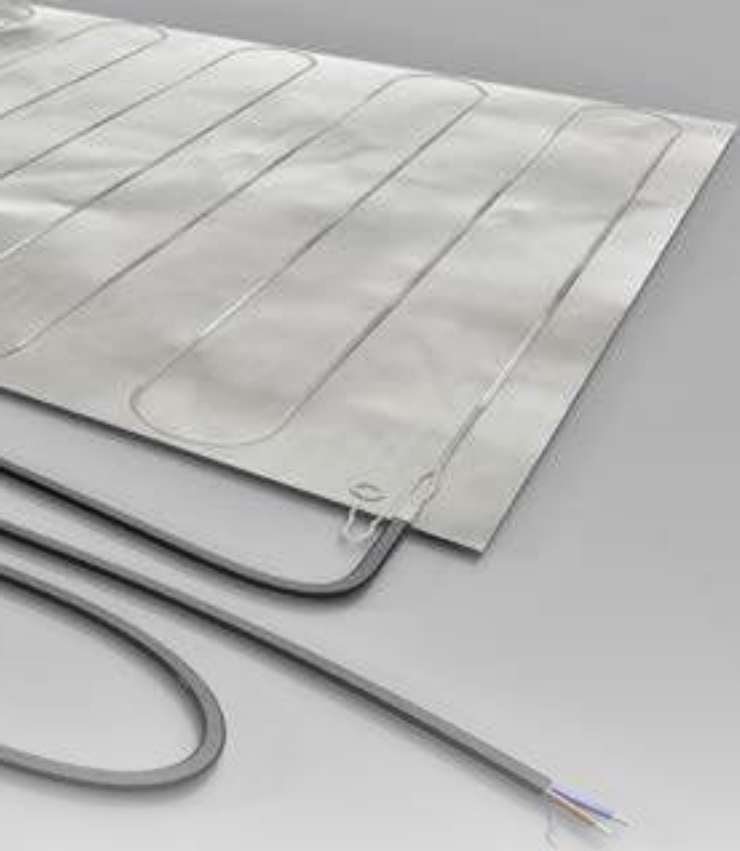

Warmup Foil Heater is an electric underfloor heating system designed for use under floating floor finishes such as wood or laminate or other floor finishes such as vinyl when combined with Warmup Dual Overlay or HiDeck18.

Its heating wires are contained within a reinforced aluminium foil matting that acts as a continuous earth layer, facilitating a consistent and even heat distribution and the mat can be cut to fit around fixed objects. The Foil Heater provides a quick, 'dry' installation with no adhesive, screed or levelling compound needed – meaning its build-up is kept low, with little impact on floor heights.

To maximise on the energy-efficiency of the system, Warmup's Insulated Underlay is recommended for installation underneath and if using the heater with a softer floor finish, our Dual Overlay System should also be installed for a durable floor deck.

Components available from Warmup

Product Code	Description
WLFH-xxW/yyyy <i>xx = 80/140 W/m²</i> <i>yyyy = Total wattage</i>	Foil heater
WIUx <i>xx = m² coverage</i>	Insulated Underlay
WDO	Warmup Dual Overlay
WDO-HIDECK18	HiDeck18
ACC-50MTAPE	Double-sided tape
6IE-01-OB-DC 6IE-01-BP-LC	Warmup 6iE
RSW-01-WH-RG (ELM-01-WH-RG) RSW-01-OB-DC (ELM-01-OB-DC)	Warmup Element
ELT PW (ELT-01-PW-01) ELT PB (ELT-01-PB-01)	Warmup tempo

Additional components that may be required as part of your Warmup heating installation:

30 mA Residual Current Device (RCD/RCBO), required as part of all installations

Overcurrent protection, such as MCB's, RCBO's or fuses

Electrical housing, back boxes and junction boxes

Electrical trunking/conduit for housing the power leads

Digital multi-meter required for testing the resistance of the heating mat and sensor

Electrical tape to secure the sensor

Step 1 - Electrical supply

- 1** The supply to the thermostat **MUST** be protected by a 30mA RCD or RCBO at all times. Time delay RCD's or RCBO's must not be used. No more than 7.5 kW of heating should be connected to each 30 milliamp RCD or RCBO. For larger loads, use multiple RCD's or RCBO's.

The heating mats must be separated from the power supply by suitably rated circuit breaker that disconnects all poles with at least 3 mm contact separation. Use MCB's, RCBO's or fuses for this purpose.

Final connections to the main electricity supply **MUST** be completed by a qualified electrician.

- 2** Manufactured joints recessed into subfloor so as they sit at the same height as the heater.

- 3** Sensor installed (300 mm) centrally between two closest parallel runs of heating cable and away from other heat sources such as hot water pipes, lighting fixtures etc.

i If taking the power supply to the heaters from an existing 30 mA RCD/RCBO protected circuit, it should be calculated whether or not the circuit can handle the additional load and if necessary the supply must be de-rated to ≤ 16 amps.

i A junction box is required if more than two heaters are being connected to a single Warmup thermostat.

i When conducting an insulation resistance test on the supply to the thermostat the thermostat and heaters must be isolated or disconnected.





1

3

Step 1 - Electrical supply



Zoning information

In the case of bathroom installations, electrical regulations prohibit the installation of mains voltage products such as thermostats, contactors, fused spurs, isolators or junction boxes, within Zones 0 or 1.

Any mains voltage product fitted within Zone 2 must have a degree of protection at least of IPX4 or IPX5 if water jets are present.

It is common to install the thermostat outside of wet rooms in the adjacent connected room in circumstances where it is not practical to install the thermostat within the wet room.

When installed in this way, using only the sensor to control the heating, it is not possible to directly control the air temperature, only the surface temperature.



All electrical connections must conform to the current BS 7671 National Wiring Regulations. Final connections to the main electricity supply MUST be completed by a Part P qualified electrician.



Typical floor build-ups

Engineered / Laminate Floating Floors

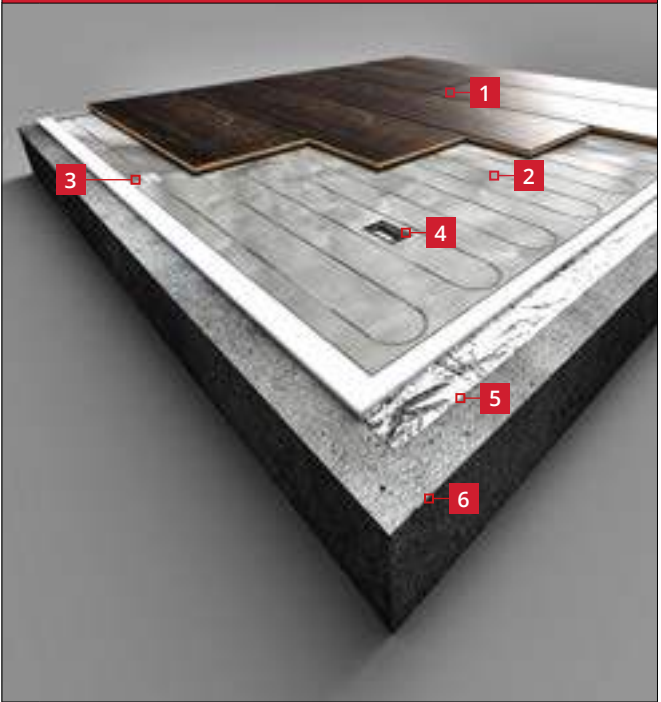

- | | |
|---|--|
| 1 | Floating floor finish |
| 2 | Warmup Foil heater |
| 3 | Aluminium foil strips
<i>They MUST bridge the gap between the cut sections of mat to ensure earth continuity</i> |
| 4 | Floor sensor
<i>Installed centrally between 2 parallel runs of heating cable</i> |
| 5 | Warmup Insulated Underlay* |
| 6 | Pre-insulated subfloor with a surface regularity of SR1 |

Typical floor build-ups

LVT / Vinyl / Laminate (Laminates requiring hard subfloor)

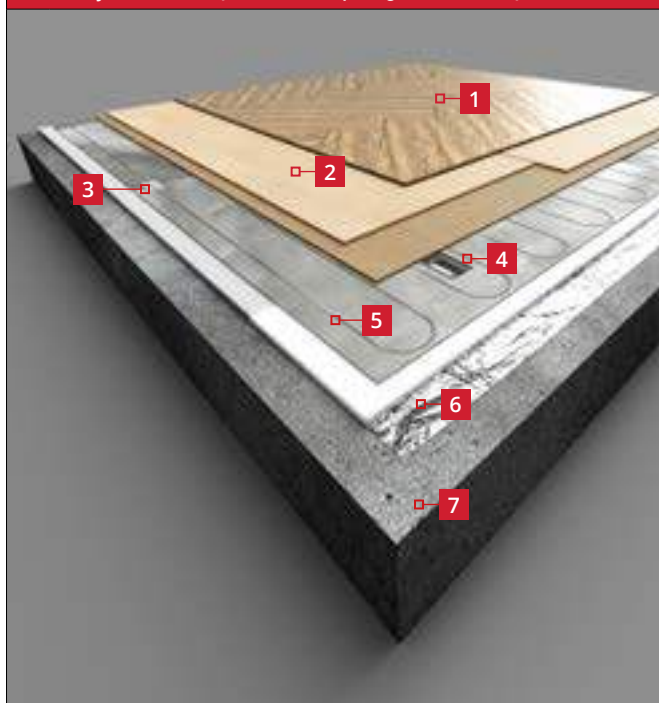

1	LVT / Vinyl / Laminate floor finish
2	Warmup Dual Overlay** <i>HiDeck18 can also be used as an overlay layer</i>
3	Aluminium foil strips <i>They MUST bridge the gap between the cut sections of mat to ensure earth continuity</i>
4	Floor sensor <i>Installed centrally between 2 parallel runs of heating cable</i>
5	Warmup Foil heater
6	Warmup Insulated Underlay*
7	Pre-insulated subfloor with a surface regularity of SR1

* Warmup Ultralight may also be used.





Please refer to its installation instructions for subfloor requirements.

** Warmup Dual Overlay is not suitable for wet areas.

Step 2 - Subfloor considerations

To prevent excessive heat loss through the floor, the Foil heater may only be laid over insulated subfloors.

The subfloor must be solid, structurally sound and dimensionally stable. Ensure the subfloor is prepared to an SR1 surface regularity. If necessary an appropriate smoothing or levelling compound should be applied.

-  Subfloors previously covered in vinyl, cork or carpeting: all old flooring and glues must be removed.
-  Any materials on or within the subfloor must be suitable for supporting electric underfloor heating systems. If using temperature sensitive materials beneath the Foil heater, such as damp proofing or tanking systems, contact the manufacturer for advice.
-  Ensure timber subfloors are prepared in accordance with national standards and manufacturer instructions are properly followed to avoid subfloor movement to prevent any damage to the system.
-  Do not commence installation of the Foil heater without ensuring that the resulting floor construction will meet the requirements of the floors intended use and its finish.

Step 3 - Subfloor preparation



- The subfloor must be pre-insulated.
- Ensure the subfloor is prepared to an SR1 Surface Regularity. The subfloor must be smooth, dry, frost-free, solid, suitably weight-bearing and dimensionally stable.
- Install Warmup Insulated Underlay referring to its instructions. The insulated underlay can be adhered to the subfloor on the short edge with double-sided tape.







Insulation **MUST** be used below the Warmup Foil Heater and **MUST** be minimum 6 mm thick and $\leq 500\text{kPa}$ compressive strength.



- If required, mark out the floor with a permanent marker showing where fixtures and other unheated areas are going to be.

Step 4 - Layout Planning

In order to fit your mat into a specific area, it may be necessary to cut and turn or rotate the mat. Please refer to the examples below for guidance.

-  Take care not to cut or damage the heating cable.
-  Ensure that all exposed heating cable is covered with the aluminium foil strips provided. They **MUST** bridge the gap between the cut sections of mat to ensure earth continuity.
-  Please take a moment to double-check that your plan has the proper room dimensions and that you have the correct size mat. Do not install under fixed objects such as kitchen or bathroom units.
-  When laying two or more systems, ensure all coldtails reach the thermostat.

Legend



Thermostat location



Beginning of Foil heater



End of Foil heater



Permanently fixed objects.
DO NOT install Foil heater underneath



Foil heater #1



Foil heater #2

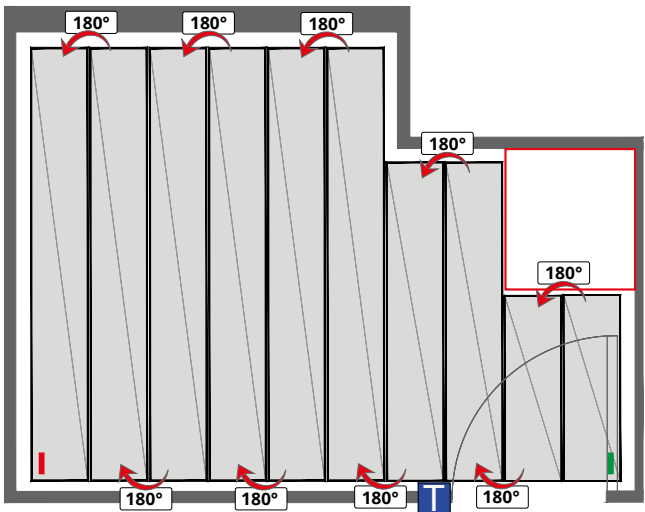

BEDROOM

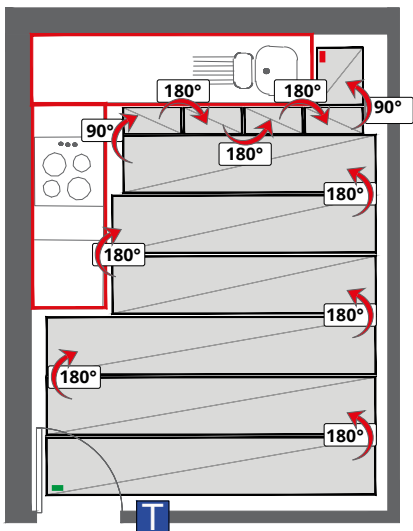

KITCHEN

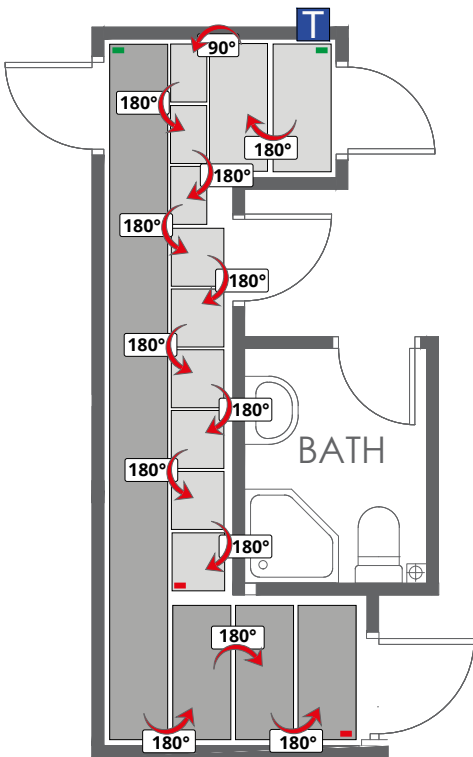

HALLWAY

Step 4 - Layout planning

i A plan of the heater layout is required as part of the control card so that any cutting or drilling after laying the system will not result in injury or damage.

Before you begin

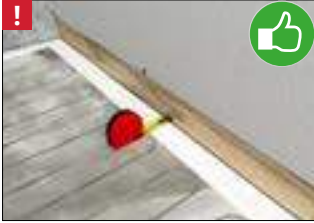

- Maintain a spacing of 50 mm between the heater and the perimeter of the room or any unheated areas.



- The heating cable must not be cut, shortened or extended.



- When installing the mat DO NOT overlap the heating mats or install over coldtails. This will cause overheating and will damage the cable.

i Ensure the heating mat is away from the influence of other heat sources, such as heating and hot water pipes, lighting fixtures or chimneys at all times.

i The mat should not be installed on irregular surfaces such as on stairs or up walls.



Step 5 - Install the Foil heater

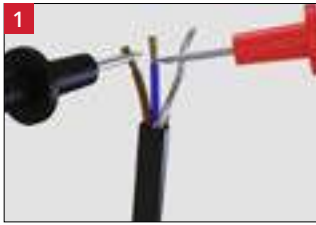

- Measure and record the resistance of the mat in the "Resistance Before" column of the control card, supplied as part of this installation guide.
- Stop installation immediately and contact Warmup if its resistance falls outside the range set out in the Reference Resistance Band table.

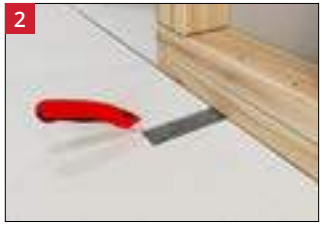

- Cut a section in the underlay for the coldtail joint and coldtail so that it sits at the same height as the heater.
- Secure the coldtail using tabs of electrical tape as necessary.



- Using double-sided tape, secure the short edge of the Foil heater to the insulated underlay.

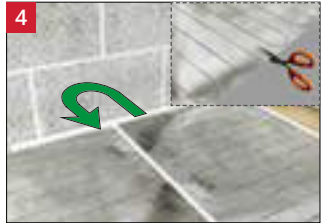

- Begin laying the mat, cutting the mat and turning/rotating the mat to fit the floor area.
- **DO NOT** install the mat in temperatures less than 0°C.



- Any exposed sections of heating cable **MUST** be bridged with the aluminium foil strips provided. This is required to maintain the earth continuity.

Step 5 - Install the Foil heater



- At the end of the mat, you will find a termination joint. As with the coldtail joint at the beginning of the mat, this joint will have to be cut into the subfloor so that it sits at the same height as the heater.



- Cut a 6mm groove for the sensor cable from the thermostat location to the sensor position.
- Cut a 50mm square section, 6mm deep into the insulated underlay for the sensor tip.



The floor sensor needs to be installed at least 300 mm into the heated area it will be controlling, located centrally between two parallel runs of cable and not in an area influenced by other heat sources.



- Apply double sided tape below the slot to stick the cut edges and the sensor wire.
- Install the floor sensor, securing to the double-sided tape.



- Lay the foil heater over the sensor and mark and cut a 30 x 50mm section around the sensor tip location taking care not to cut the heater cable or sensor wire.

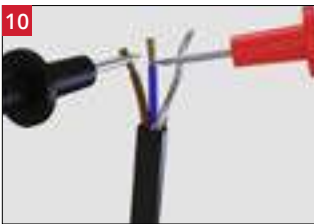

- Measure the resistance of the mat and verify it is still in line with the Resistance Before reading previously taken.
- Stop installation immediately and contact Warmup if its resistance has changed significantly or if it falls outside the range set out in the Reference Resistance Band table.

Step 6 - Select floor covering

- i** Before installing any floor finish, the installation requirements of each must be checked to ensure compatibility with underfloor heating.
- i** If installing a floor covering which must be laid over a hard surface HiDeck18 or Dual Overlay **MUST** be used.

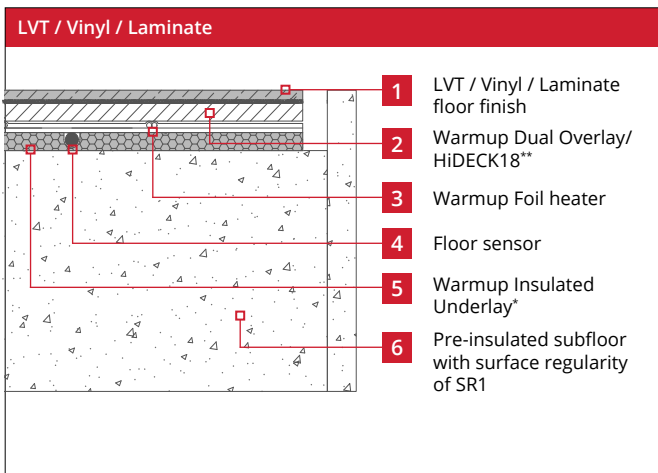
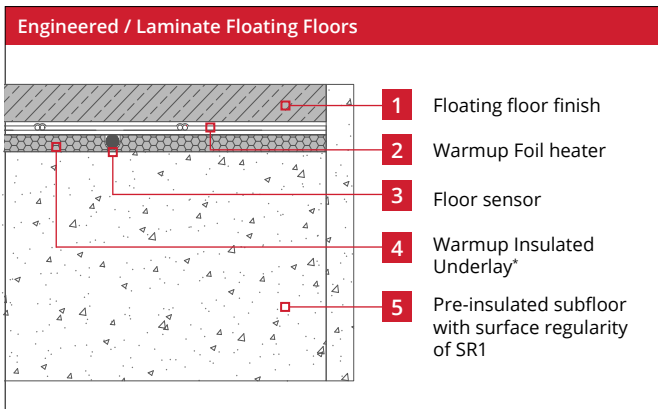





* Warmup Ultralight may also be used.

Please refer to its installation instructions for subfloor requirements.

** Dual Overlay is limited for use with floors which require a hard surface to be installed on such as LVT, Vinyl and CERTAIN Laminates, check with flooring manufacturer for guidance. Warmup Dual Overlay is not suitable for wet areas

Step 7 - Lay floor covering

-  The maximum thermal resistance above the Foil heater should not exceed 0.175 m²K/W. This includes mattresses, bean bags etc.
-  Underlays used above the Foil heater **MUST** be suitable for use with electric underfloor heating systems.
-  Adhesives/glues used over Warmup Dual Overlay/Hideck18 **MUST** be suitable for use with electric underfloor heating systems.
-  Warmup Dual Overlay is not suitable for wet areas, such as bathrooms.
-  Nailed wood floors are not suitable for use with the Foil heater.

Engineered / Laminate Floating Floors



- Install the floating floor finish referring to the manufacturer instructions on its installation and underlay requirements.



- When the floor has been installed, conduct another resistance test to ensure the sensor and heating mat have not been damaged and record in the control card.

LVT / Vinyl / Laminate (Laminates requiring hard subfloor)



- Install Warmup Dual Overlay or HiDeck18 over the Foil heater referring to its installation instructions.



- Finally lay the floor covering adhering to the flooring manufacturers instructions.



- When the floor has been installed, conduct another resistance test to ensure the sensor and heating mat have not been damaged and record in the control card.

Step 8 - Connect the thermostat

i Install the thermostat in accordance with its installation instructions

Instructions for fitting Warmup® thermostats can be found inside the thermostat box. The thermostat should be connected to the main electrical supply by suitably rated circuit breaker that disconnects all poles with at least 3 mm contact separation. Use MCB's, RCBO's or fuses for this purpose.

The system power cable consists of conductors coloured brown (live), blue (neutral) and earth braid. If you are installing more than one heating mat a junction box will be required. Final connections to the main electricity supply **MUST** be completed in accordance with the wiring regulations by a qualified electrician.

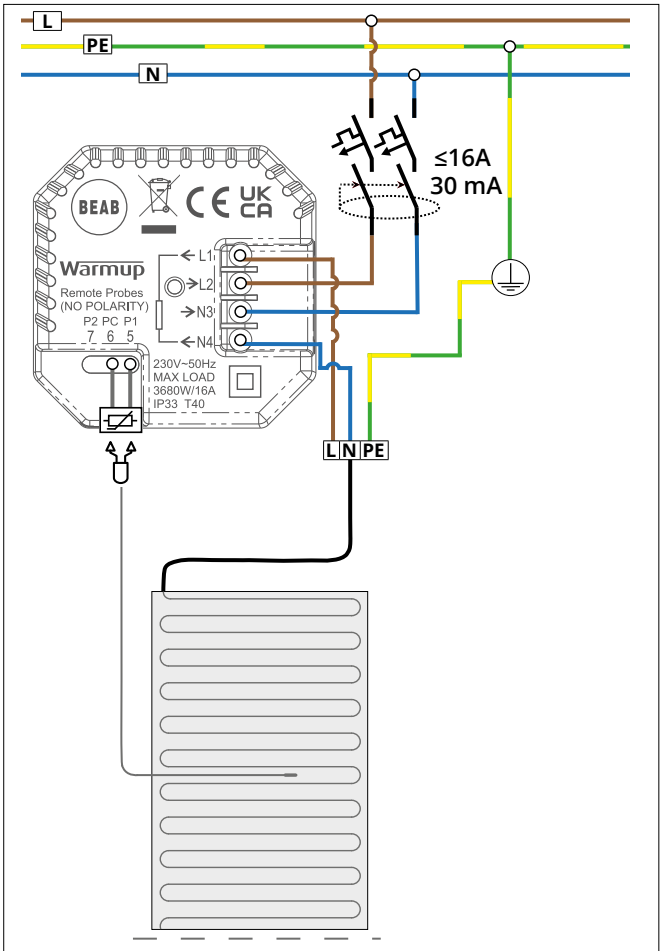

Step 8 - Connect the thermostat (Load exceeding 16 Amps)

Warmup thermostats are rated for a maximum of 16 amps (3680 W at 230 V AC). A contactor must be used to switch loads exceeding 16 amps.

If using contactors which exceed 16 amps, the supply to the heating mat(s) must be de-rated using fused spur(s) ≤ 16 Amps to provide overcurrent protection. Please see wiring diagram below.

 Thermostat wiring with a contactor must be completed by a qualified electrician.

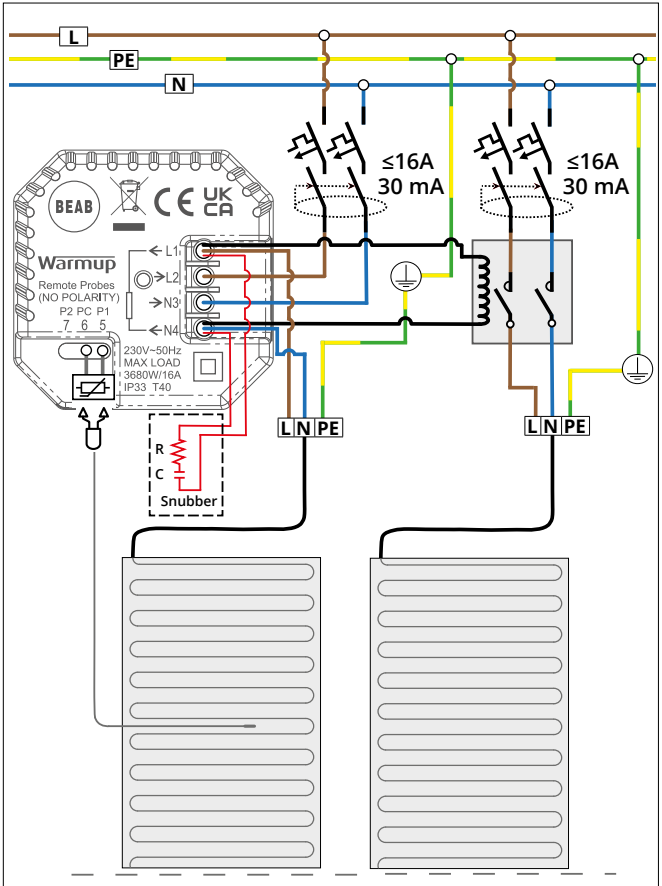

Troubleshooting

HEATING ISSUE 1 - The floor does not heat up

Instructions which are shaded must be completed by a qualified electrician

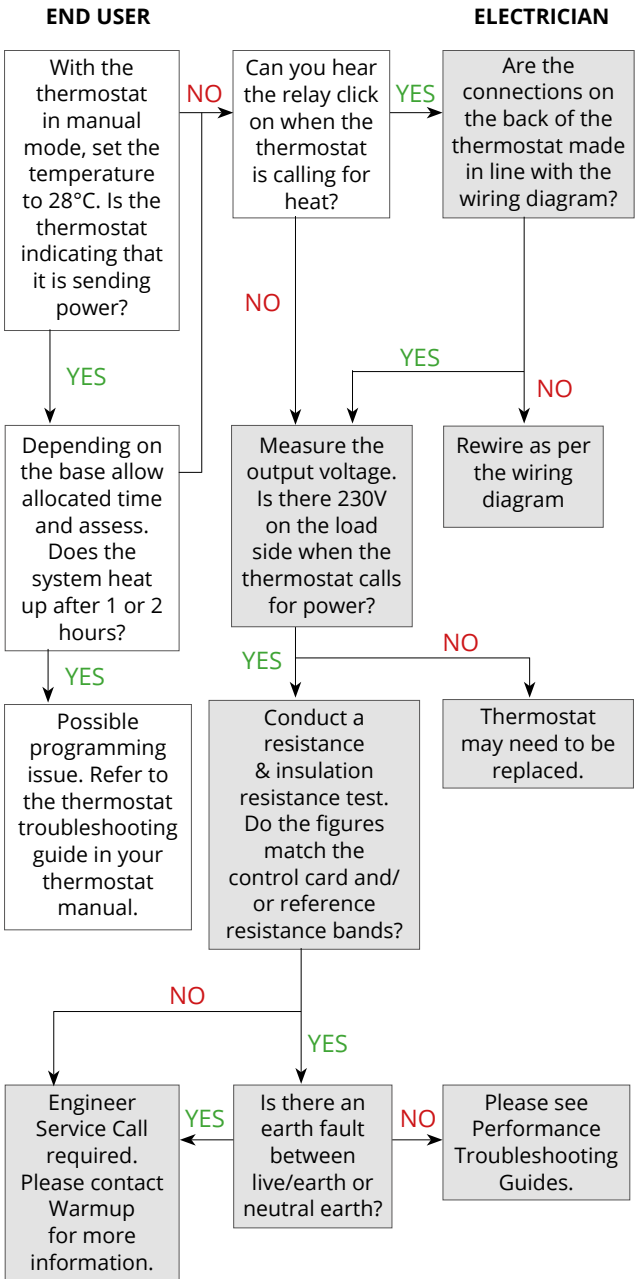

HEATING ISSUE 2 - The heating mat trips the RCD

Instructions which are shaded must completed by a qualified electrician

ELECTRICIAN

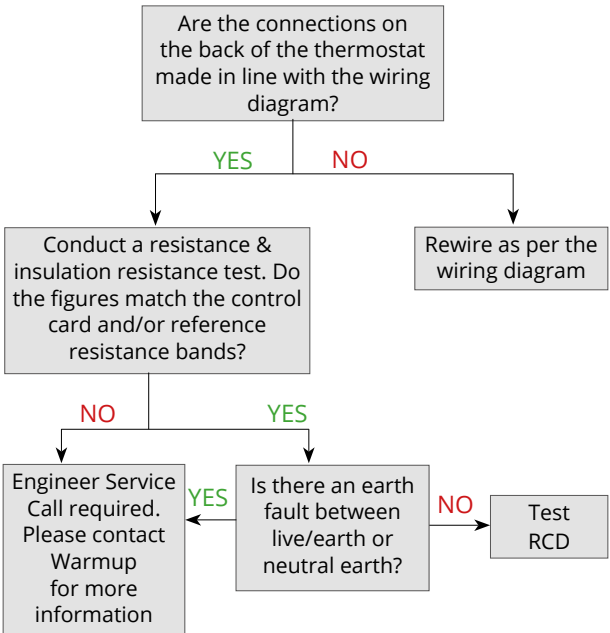



ISSUE 1 - My floor is getting too hot

PROBLEM		SOLUTION
1	The floor temperature settings on the thermostat may be incorrect.	Check the thermostat settings ensuring that it is controlling the floor surface temperature and that the set target and limiting temperatures are correct.
2	The floor sensor may be poorly positioned, if so the thermostat will be displaying a floor temperature that is not indicative of the floor surface temperature.	Recalibrate the floor sensor in the thermostat settings.
3	The thermostat may be set in regulator mode with the duty cycle set too high.	If the thermostat cannot be set to reference a floor sensor, reduce the regulation value to its minimum selectable value. With the heating active, incrementally increase the setting at an hourly interval until the required floor surface temperature is achieved.

ISSUE 2 - My floor does not get up to temperature

PROBLEM		SOLUTION
1	Underfloor heating is normally designed to heat floors to up to 9 °C above the design room air temperature, which is typically 29°C. Delicate floor finishes, such as vinyl and some timbers, may be limited to 27 °C. Our hand and foot temperature is normally similar to this, at around 29 - 32 °C, so the heated floor will feel slightly cooler than touching your own hands together.	If you wish to raise the floor temperature, such that it feels warm, it is permissible to set it up to 15 °C higher than the design room air temperature. The higher heat output of the floor may overheat the room, making it uncomfortable. The manufacturer of the floor finish should be consulted to ensure compatibility with the chosen temperature before making any changes to the thermostat settings.
	Refer to points 1, 2 & 3 in the “My floor is getting too hot” above, as each issue can also be the cause of under heating a floor.	
2	If the thermostat is controlling the heating using the air temperature, with a floor temperature limit then the floor may be turned off before it reaches its limit.	This is normal as the thermostat is preventing the room air temperature from becoming overheated.
3	The heating system may be uninsulated. If the system has not been installed over a layer of insulation, it will be actively heating the subfloor as well as the floor finish. The warm up period of the floor will therefore be slower as the system is heating a much greater mass. It could take several hours if it is installed directly on a thick layer of uninsulated concrete.	If your thermostat has an optimised start feature, ensure it is enabled so that the thermostat can compensate for the mass of the floor. If your thermostat does not have an optimised start feature, measure the time taken for the floor to warm up and adjust the heating start time to compensate.

Performance troubleshooting

4	The heat output of the installed system may not be sufficient. The system will require a power output of approximately 10 W/m ² for every degree warmer you require the floor to be than the air. This is in addition to any heat loss downwards through the subfloor	If the room air temperature is also lower than desired, supplementary heating may be required to overcome the room heat losses. If access is available to the underside of the subfloor, installing insulation within the floor will reduce the amount of heat lost through the floor.
5	Floor coverings such as carpets, underlays and timber are thermally resistive and will reduce the achievable floor surface temperature. They may also require the floor sensor to be recalibrated.	Floor finish combinations with a thermal resistance of more than 0.175 m ² K/W or 1.75 tog are not permitted and we recommend that you look to fit a less resistive floor finish.
ISSUE 3 - I am getting patchy heat across my floor		
	If the subfloor varies across the floor, the amount of heat absorbed by it and lost through it will affect the floor surface temperatures differently above each case.	
	If the floor covering over the underfloor heating changes, each floor finishes characteristics will affect the warm up period and the achievable surface temperature.	
	Hot water pipes under the floor could cause parts of the floor to seem warmer than others.	

Testing information



Each heating mat and sensor must be tested before they are installed, once they have been laid but before laying the floor covering / deck and again before they are connected to the thermostat. The resistance (ohms) should be measured and recorded in the control card at the end of the manual.



Due to the high resistance of the heating mat, it may not be possible to get a continuity reading from the heating mat and as such, continuity testers are not an acceptable substitution for testing. When checking resistance, make sure your hands do not touch the meter's probes as the measurement will include your internal body resistance and render the measurement inaccurate. If you do not get the expected results or at any time you believe there may be a problem, please contact Warmup for guidance.

Heating mat resistance test

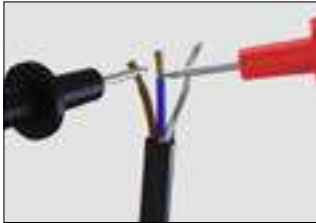

- Set a multimeter or ohmmeter to record resistance in the range of 0-500 Ω . Measure the resistance across the live (brown) and neutral (blue) wires. Ensure the measured resistance is within the Reference Resistance Band for the mat size being tested

Earth fault test



- Set a multimeter or ohmmeter to record resistance in the range of 1 M Ω or greater if available. Measure the resistance across the live (brown) and neutral (blue) wires to the earth braid. Ensure the measured resistance is showing as greater than 500 M Ω or infinite if the meter cannot read this high.
- Set an insulation resistance tester to 1000 V DC. Measure the resistance across the live (brown) and neutral (blue) wires to the earth braid wire. After 1 minute of application, ensure the measured resistance is showing greater than 50 M Ω to indicate a pass.

Testing information

Sensor resistance test



- Ensure that the sensor is tested before the final finish has been fitted. Warmup thermostats typically use a 10 k Ω sensor. Please refer to the thermostat manual for further details.

The expected resistance depending on temperature is listed below.

Sensor resistance by temperature - NTC10K

Temperature	Resistance	Temperature	Resistance
0 °C	32.8 k Ω	16 °C	15.0 k Ω
2 °C	29.6 k Ω	18 °C	13.7 k Ω
4 °C	26.8 k Ω	20 °C	12.5 k Ω
6 °C	24.2 k Ω	22 °C	11.4 k Ω
8 °C	22.0 k Ω	24 °C	10.5 k Ω
10 °C	19.9 k Ω	26 °C	9.6 k Ω
12 °C	18.1 k Ω	28 °C	8.8 k Ω
14 °C	16.5 k Ω	30 °C	8.1 k Ω

Technical specifications

Product code	WLFH-xxW/yyyy <i>xx = 80/140 W/m²</i> <i>yyyy = Total wattage</i>
Operating voltage	230 V AC: 50 Hz
Connection	3.0 m coldtail (2-core & earth)
Coldtail size	2Cx0.75 mm ² (Up to 6.0A) & 2Cx1.0 mm ² (> 6.0A to 10.0A)
IP rating	X7
Output rating	140 W/m ² / 80W/m ²
Heating cores	Dual core, solid-strand heating element
Cable spacing	50mm
Insulation	ETFE
Earth protection	Reinforced aluminium foil mat that acts as a continuous earth layer
Minimum installation temperature	0 °C

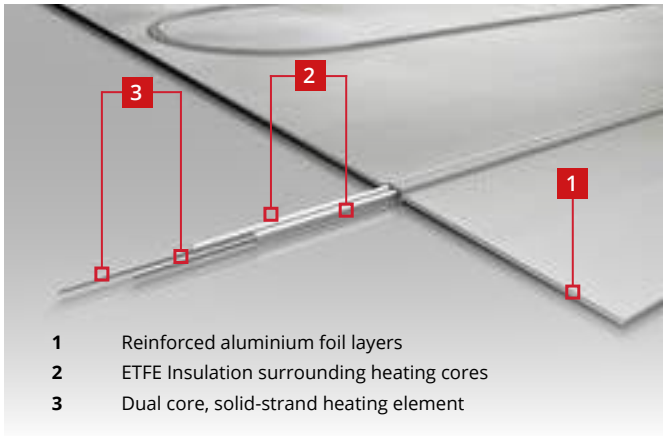

Technical specifications

140 W/m² Foil heater

Product code	Mat size	Cable length	Power	Current	Resistance		
	m (m ²)	(m)	(W)	(A)	-5%	Nom. (Ω)	+5%
WLFH-140W/140	0.5x2 = 1m ²	20.6	140	0.61	359.0	377.9	396.8
WLFH-140W/210	0.5x3 = 1.5m ²	30.9	210	0.91	239.3	251.9	264.5
WLFH-140W/280	0.5x4 = 2m ²	41.2	280	1.22	179.5	188.9	198.4
WLFH-140W/420	0.5x6 = 3m ²	61.8	420	1.83	119.7	126.0	132.2
WLFH-140W/560	0.5x8 = 4m ²	82.3	560	2.43	89.7	94.5	99.2
WLFH-140W/700	0.5x10 = 5m ²	102.9	700	3.04	71.8	75.6	79.3
WLFH-140W/840	0.5x12 = 6m ²	123.5	840	3.65	59.8	63.0	66.1
WLFH-140W/980	0.5x14 = 7m ²	144.1	980	4.26	51.3	54.0	56.7
WLFH-140W/1120	0.5x16 = 8m ²	164.7	1120	4.87	44.9	47.2	49.6
WLFH-140W/1260	0.5x18 = 9m ²	185.3	1260	5.48	39.9	42.0	44.1
WLFH-140W/1400	0.5x20 = 10m ²	205.8	1400	6.09	35.9	37.8	39.7
WLFH-140W/1680	0.5x24 = 11m ²	247.0	1680	7.30	29.9	31.5	33.1

80 W/m² Foil heater

Product code	Mat size	Cable length	Power	Current	Resistance		
	m (m ²)	(m)	(W)	(A)	-5%	Nom. (Ω)	+5%
WLFH-80W/80	0.5x2 = 1m ²	20.6	80	0.35	628.2	661.3	694.3
WLFH-80W/120	0.5x3 = 1.5m ²	30.9	120	0.52	418.8	440.8	462.9
WLFH-80W/160	0.5x4 = 2m ²	41.2	160	0.70	314.1	330.6	347.2
WLFH-80W/240	0.5x6 = 3m ²	61.8	240	1.04	209.4	220.4	231.4
WLFH-80W/320	0.5x8 = 4m ²	82.3	320	1.39	157.0	165.3	173.6
WLFH-80W/400	0.5x10 = 5m ²	102.9	400	1.74	125.6	132.3	138.9
WLFH-80W/480	0.5x12 = 6m ²	123.5	480	2.09	104.7	110.2	115.7
WLFH-80W/560	0.5x14 = 7m ²	144.1	560	2.43	89.7	94.5	99.2
WLFH-80W/640	0.5x16 = 8m ²	164.7	640	2.78	78.5	82.7	86.8
WLFH-80W/720	0.5x18 = 9m ²	185.3	720	3.13	69.8	73.5	77.1
WLFH-80W/800	0.5x20 = 10m ²	205.8	800	3.48	62.8	66.1	69.4

Floor sensor setting for target heat output

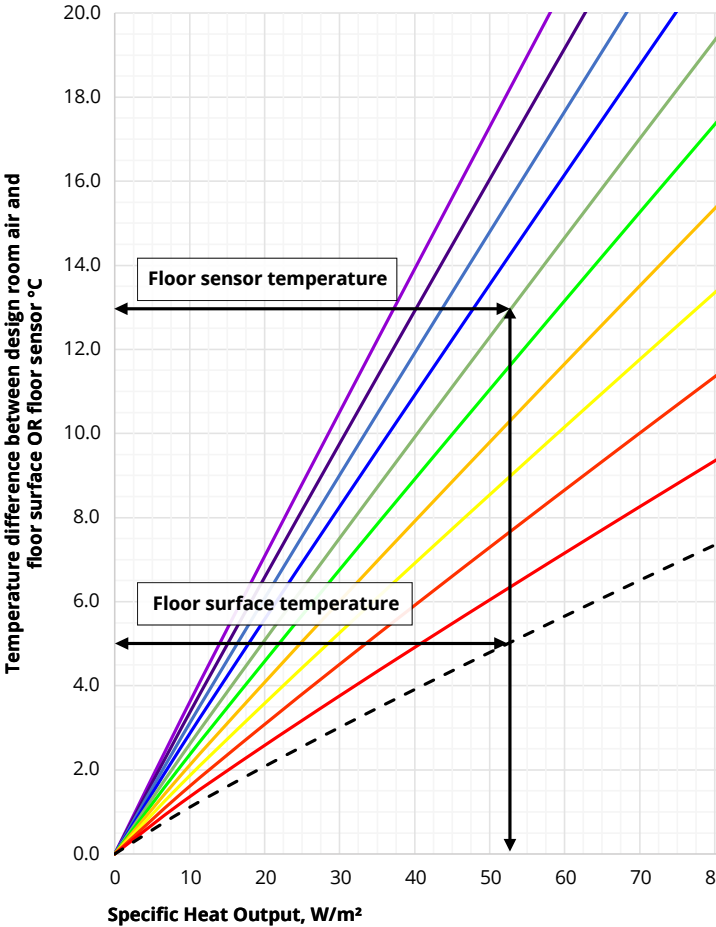

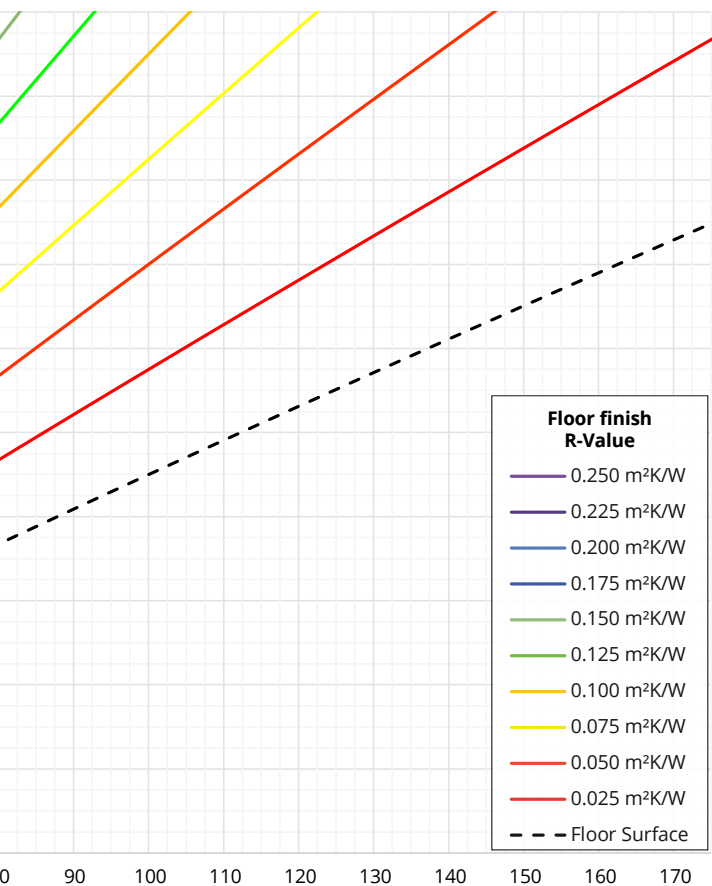

Using the graph above it is possible to get the specific heat output of an eUFH system based on the temperature difference between the design room air temperature and the floor surface or floor sensor temperature by floor finish.

The example above shows a design room air temperature of $20^{\circ}C$ and floor surface temperature of $25^{\circ}C$. Based on the temperature difference of $5^{\circ}C$ the resulting heat output would be $52.5 W/m^2$. Based on a $0.150 m^2K/W$ (1.5 Tog) floor finish the floor sensor would have to be set to $33^{\circ}C$ to achieve this heat output.



Specific Heat Output, W/m²

-  The design floor surface temperature difference should not be more than 9 °C in occupied areas, 15 °C in unoccupied areas.
-  Heat output is limited by the floor finish resistance combined with the maximum probe setting of 40 °C.
-  Temperature limits of the floor finish or its adhesive may adversely limit the design heat output.

Warranty



Warmup® underfloor heating is guaranteed by Warmup plc (“Warmup”) to be free from defects in materials and workmanship under normal use and maintenance, and is guaranteed to remain so subject to the limitations and conditions described below. Warmup Foil heater(s) are guaranteed for 15 years when installed beneath the floor covering under which it is fitted, except as provided below (and your attention is drawn to the exclusions listed at the end of this guarantee).

This guarantee applies:

- 1 Only if the unit is registered with Warmup within 30 days after purchase. Registration can be completed online at www.warmup.co.uk. In the event of a claim, proof of purchase is required, so keep your invoice and receipt - such invoice and receipt should state the exact model that has been purchased;
- 2 Only if the heating system has been earthed and protected by a Residual Current Device (RCD/RCBO) at all times.



All Warmup warranties are voided if the floor covering installed over Warmup heating mat(s) are damaged, lifted, replaced, repaired or covered with subsequent layers of flooring. The warranty period begins on the date of purchase. During the period of the guarantee Warmup will arrange for the heating system to be repaired or (at its discretion) have parts replaced free of charge or issue a refund for the product only. The cost of the repair or replacement is your only remedy under this guarantee which does not affect your statutory rights.

Such cost does not extend to any cost other than direct cost of repair or replacement by Warmup and does not extend to costs of relaying, replacing or repairing any floor covering or floor. If the system fails due to damage caused during installation or tiling, this guarantee does not apply. It is therefore important to check that the system is working (as specified in the installation manual) prior to laying the floor covering.

WARMUP PLC SHALL IN NO EVENT BE LIABLE FOR INCIDENTAL OR CONSEQUENTIAL DAMAGES, INCLUDING BUT NOT LIMITED TO EXTRA UTILITY EXPENSES OR DAMAGES TO PROPERTY.

Warmup plc is not responsible for:

- 1 Damage or repairs required as a consequence of faulty installation or application.
- 2 Damage as a result of floods, fires, winds, lightening, accidents, corrosive atmosphere or other conditions beyond the control of Warmup plc.
- 3 Use of components or accessories not compatible with this unit.
- 4 Products installed outside of any country or territory within which Warmup operates.
- 5 Normal maintenance as described in the installation and operating manual, such as cleaning thermostat.
- 6 Parts not supplied or designated by Warmup.
- 7 Damage or repairs required as a result of any improper use, maintenance, operation or servicing.
- 8 Failure to start due to interruption and/or inadequate electrical service.
- 9 Any damage caused by frozen or broken water pipes in the event of equipment failure.
- 10 Changes in the appearance of the product that does not affect its performance.

Control card

Warning!

Radiant direct floor heating system. Risk of shock or fire



Flexible sheet heating units are installed within the floor. DO NOT penetrate with nails, screws, or similar devices. DO NOT restrict the thermal emission of the heated floor. DO NOT affix materials other than those recommended

Checklist - Installer

Is the heating system, including manufactured joints, installed underneath a load bearing floating floor?

Is the heating system installed over a minimum 6 mm thick, $\leq 500\text{kPa}$ compressive strength underlay?

Model	Location	Power	System resistance			Insulation resistance test	Sensor resistance
			Before	During	After		

Installer name, company:

Installer signed: Date:

Checklist - Electrician

Is the heating system protected by a dedicated 30 mA RCD/RCBO or an existing RCD/RCBO? **Time delay RCD's must not be used.**

Is the system separated from the power supply by suitably rated circuit breaker that disconnects all poles with at least 3 mm contact separation, for example, MCB's, RCBO's or fuses?

Model	Location	Power	System resistance		Insulation resistance test	Sensor resistance
			Pre-connection			

Electrician name, company:

Electrician signed: Date:

This form must be completed as part of the Warmup Guarantee. Ensure that the resistance values are as per the instruction manual. This control card, a layout plan and EcoDesign compliance information card must be left permanently fixed near the consumer unit.

Warmup plc T: 0345 345 2288 F: 0345 345 2299 www.warmup.co.uk
704 Tudor Estate ■ Abbey Road ■ London ■ NW10 7UW ■ UK
Warmup GmbH ■ Ottostraße 3 ■ 27793 Wildeshausen ■ DE



EcoDesign compliance information card

This product is an electric underfloor local space heater and, in order to be compliant with the mandatory EcoDesign requirements set out in Commission Regulation (EU) 2024/1103, needs to be complemented with a control providing at least the following control functions:

Type of heat output/room temperature control (one of)

TD	Electronic room temperature control plus day timer (Minimum of 3 control options required)	<input type="checkbox"/>
TW	Electronic room temperature control plus week timer (Minimum of 1 control options required)	<input type="checkbox"/>

Other control options (multiple selections possible)

f2	Open window detection	<input type="checkbox"/>
f3	Distance control option	<input type="checkbox"/>
f4	Adaptive start control	<input type="checkbox"/>
f7	Self-learning functionality	<input type="checkbox"/>
f8	Control accuracy	<input type="checkbox"/>

Room temperature control power consumption

The control must have an off mode, standby mode or both and must comply where the function exists

In off mode	$P_o \leq 0.5W$	<input type="checkbox"/>
In standby mode (select one)	$P_{sm} \leq 0.5W$	<input type="checkbox"/>
	$P_{dsm} \leq 1.0W$ (if control has an active display in standby mode)	<input type="checkbox"/>
	$P_{nsm} \leq 2.0W$ (if control has a network connection in standby mode)	<input type="checkbox"/>
In idle mode (select one)	$P_{idle} \leq 1.0W$	<input type="checkbox"/>
	$P_{nidle} \leq 3.0W$ (if control has a network connection)	<input type="checkbox"/>

The following Warmup thermostats include these control function codes and power consumptions:

Thermostat model	Control function code	Power consumption					
		Off mode	Standby mode			Idle mode	
		$P_o \leq 0.5W$	$P_{sm} \leq 0.5W$	$P_{dsm} \leq 1.0W$	$P_{nsm} \leq 2.0W$	$P_{idle} \leq 1.0W$	$P_{nidle} \leq 3.0W$
Tempo	TW (f4/f8)	<input checked="" type="checkbox"/>				<input checked="" type="checkbox"/>	
Element	TW (f2/f3/f4/f8)				<input checked="" type="checkbox"/>		<input checked="" type="checkbox"/>
6iE	TW (f2/f3/f4/f8)	<input checked="" type="checkbox"/>			<input checked="" type="checkbox"/>		<input checked="" type="checkbox"/>

For the combined heat output of all local electric space heaters attached to an individual control please refer to the technical specification page of this manual.

If using alternative thermostats, you must complete the above card according to the definitions of the control function codes specified in Regulation (EU) 2024/1103 to ensure compatibility with this local electric space heater.

Only functions that are active after the control has been commissioned can be declared and used for compliance.

Control function codes

Required to be in manual as part Regulation (EU) 2024/1103

		Code of temperature control (TC)	Control functions							
			f1	f2	f3	f4	f5	f6	f7	f8
Type of temperature control	Single stage, no temperature control	NC								
	Two or more manual stages, no temperature control	TX								
	Mechanic thermostat room temperature control	TM								
	Electronic room temperature control	TE								
	Electronic room temperature control plus day timer	TD								
	Electronic room temperature control plus week timer	TW								
Control functions	Presence detection		1							
	Open window detection			2						
	Distance control option				3					
	Adaptive start control					4				
	Working time limitation						5			
	Black bulb sensor							6		
	Self-learning functionality								7	
	Control accuracy with CA < 2 Kelvin and CSD < 2 Kelvin									8



SafetyNet™ Installation Guidelines: If you make a mistake and damage the new heating system before laying the floor covering, return the damaged system to Warmup within in 30 days along with your original dated sales receipt.

WARMUP WILL REPLACE ANY PRE-TILED HEATING SYSTEM (MAXIMUM 1 SYSTEM) WITH ANOTHER HEATING SYSTEM OF THE SAME MAKE AND MODEL - FREE.

- 1 Repaired systems carry a 5 year warranty only. Under no circumstances is Warmup responsible for the repair or replacement of any tiles / floor covering which may be removed or damaged in order to affect the repair.
- 2 The SafetyNet™ Installation Guarantee does not cover any other type of damage, misuse or improper installation due to improper adhesive or subfloor conditions. Limit of one free replacement system per customer or installer.
- 3 Damage to the system that occurs after tiling, such as lifting a damaged tile once it has set, or subfloor movement causing floor damage, is not covered by the SafetyNet™ Guarantee.

Disposal information



Do not dispose with regular domestic waste! Electronic equipment must be disposed of at local collection points for waste electronic equipment in compliance with the Waste Electrical and Electronic Equipment Directive.



Warmup plc

www.warmup.co.uk

uk@warmup.com

Tel: 0345 345 2288

Fax: 0345 345 2299



**Please scan the QR code to provide
feedback on your installation**

Warmup

The WARMUP word and associated logos are trade marks.
© Warmup Plc. 2024 – Regd.™ Nos. 1257724, 4409934, 4409926,
5265707. E & OE.

Warmup plc ■ 704 Tudor Estate ■ Abbey Road ■ London ■ NW10 7UW ■ UK

Warmup GmbH ■ Ottostraße 3 ■ 27793 Wildeshausen ■ DE

Warmup - IM - Foil - V1.2 - 2024-11-22_EN